

Invisible sophistication.
Visible simplicity.



CS 8100



Welcome to the simplicity of
compact panoramic imaging



Introducing the CS 8100



Sophisticated technology made thoughtfully simple

At Carestream Dental, we're redefining panoramic imaging and making a league of our own. With compact panoramic imaging, the CS 8100 combines the most advanced, sophisticated imaging technology in one extremely simple and compact system. In fact, it's the intelligence and sophistication behind the CS 8100 that gives you the added simplicity. These innovative features help you to provide the very best patient care, while making your daily work simpler and more intuitive.

Key benefits:

- Perfect for everyday panoramic needs
- Effortless high-quality digital results
- Outstanding value for money
- Sleek, ultra-compact and elegant
- "Plug-and-pan" solution – Easy to install, learn and use

Giving you the best value for money without the added complexity of unnecessary programs or gadgets, the CS 8100 makes positioning easier, image acquisition faster and higher image quality more accessible. Essentially it's exactly what you need to streamline your workflow, improve your usability and make a more accurate, real-time diagnosis.

The Carestream Dental Factor

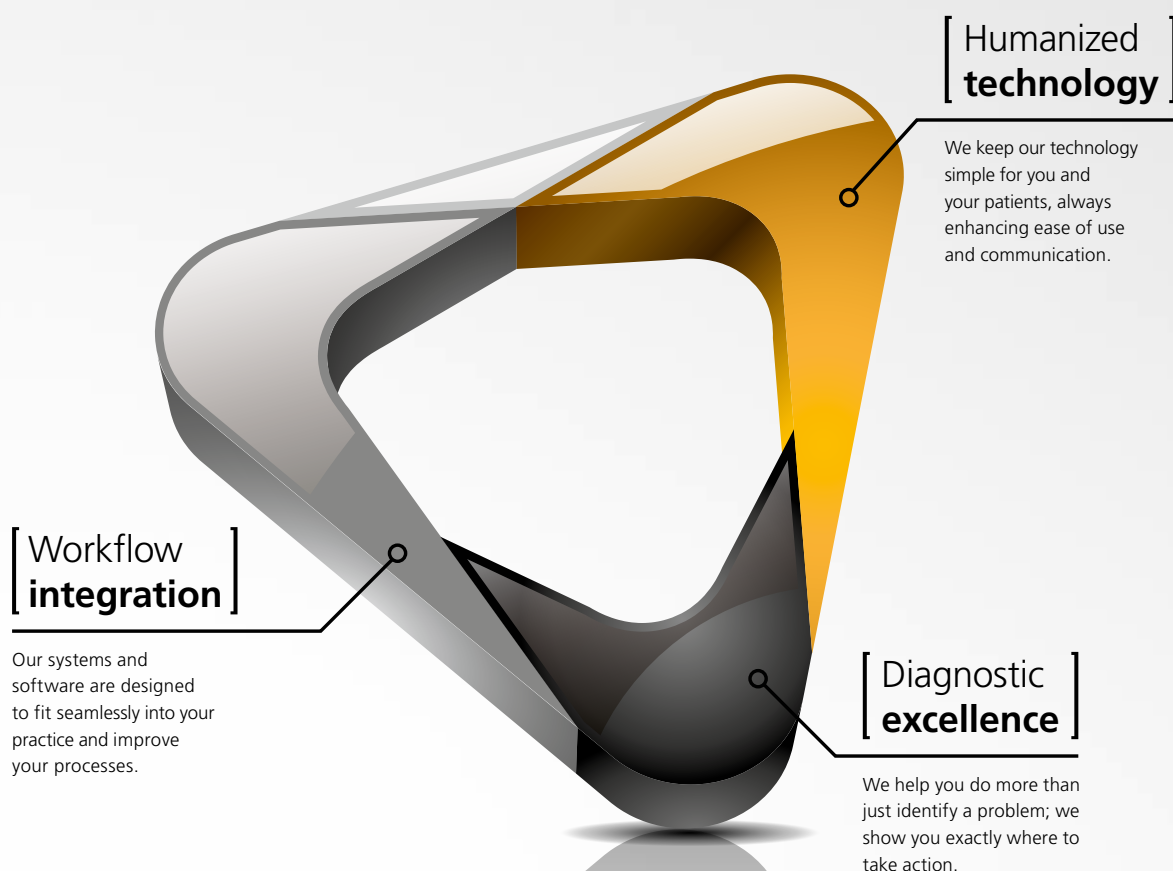

Built on three essential cornerstones

Like all Carestream Dental products, the CS 8100 is built on three essential cornerstones: workflow integration, humanized technology and diagnostic excellence. Together they make up the Carestream Dental Factor.

The Carestream Dental Factor is how together we can redefine the meaning of dental expertise and help you provide the best possible patient care.

Using advanced technology built on years of experience, our aim is to streamline your workflow and help you make more accurate diagnoses that your patients can easily understand.

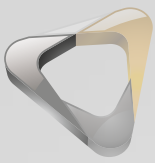

[Workflow **integration**]

A real-time diagnosis in four simple steps

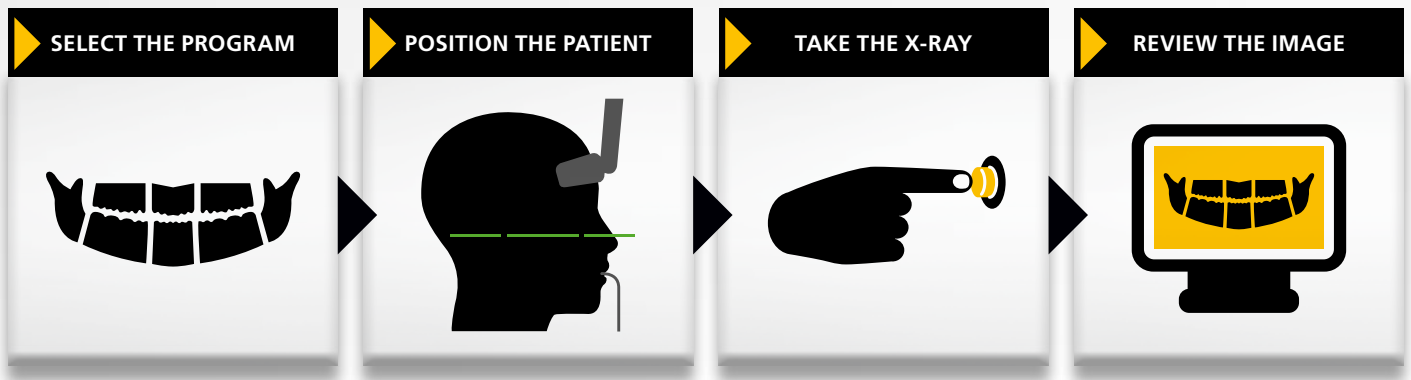

Simply select the program, enter the patient information, and if necessary, adjust the exposure settings.

Face-to-face positioning, clear user instructions and innovative head support make patient positioning easy with no need for laser beams.

With just a touch of a button, the acquisition starts and the image is sent directly to your computer.

Reviewing sharp, high-quality images leads to a more accurate diagnosis and treatment.

Quick and easy operation

Waiting for film to develop is now a thing of the past. The advanced digital technology of the CS 8100 allows you to spend less time waiting for images and performing routine tasks and more time providing patient care.

The intuitive user interface and computer controlled system make selecting settings and entering patient information easy, with pre-set programs and exposure settings to minimize set-up time and errors. And positioning is simpler than it ever has been. Clear

instructions help you position the patient correctly, and transparent patient support helps hold the patient comfortably in place.

A quick acquisition time of just 10 seconds minimizes the risk of patient movement and the need for retakes. Almost immediately following, a perfectly sharp, high-quality image will be ready for your review using our dental imaging software. Four simple steps are all it takes for a real-time diagnosis.

Literally fits any practice



Easily integrated and compact

The simple workflow of the CS 8100 aligns seamlessly with the current processes of your practice. The system connects via Ethernet directly to your network, and our imaging software can be used as a standalone program or integrated with your existing practice management program.

Not to mention, due to the ultra compact size of the unit, the CS 8100 easily fits tight spaces and offers versatile installation possibilities. It's new sleek aluminum body, motorized telescopic column, miniaturized X-ray generator and sensor make the unit extremely thin and compact, lighter and more robust. And the CS 8100 is delivered in smart packaging for fast and easy installation that can be performed by just one person.



New design with sleek and robust aluminum body.



[Humanized **technology**]

A perfect fit for every patient...



reddot design award
winner 2013

Easily adjustable for patients of all sizes

The CS 8100 can be easily adjusted for patients standing or sitting, and is wheelchair accessible. Motorized movements of the machine provide precise and effortless height adjustments, and silent movements put your patients more at ease.

An open design, face-to-face positioning and transparent patient support with integrated handgrips facilitate proper patient positioning, and help your patients feel secure and less claustrophobic or confined. In general, your patients will appreciate the convenience of a faster, more comfortable exam. And the exam will be safer for them as well, requiring a lower dose compared to traditional panoramic systems.



Award-winning design
that appeals to both
users and patients alike.





...and every staff member

The right positioning for successful images

Combined with enhanced patient comfort, the CS 8100 offers increased positioning usability for dentists and dental assistants alike.

Simple step-by-step instructions on the modern user interface guide you through the process and minimize errors. And three different anatomical programs adapt to your patients' jaw morphology in order to capture a more accurate representation of the dental structures.

Compared to traditional panoramic units, the increased thickness and width of the CS 8100's focal trough eliminate the need for laser beams for the midsagittal and Frankfort planes, and provide greater tolerance to imperfect positioning and challenging anatomy, especially in the anterior area. The enhanced focal trough, together with an optimized positioning system, ultimately improve positioning, reduce the risk of retakes and streamline your workflow even further.



Unlike most panoramic units, the CS 8100's focal trough has an increased thickness in the anterior region, making it easier to place teeth in the sharpness area.

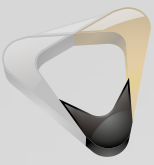

[Diagnostic **excellence**]

Excellent image quality for excellent diagnostics

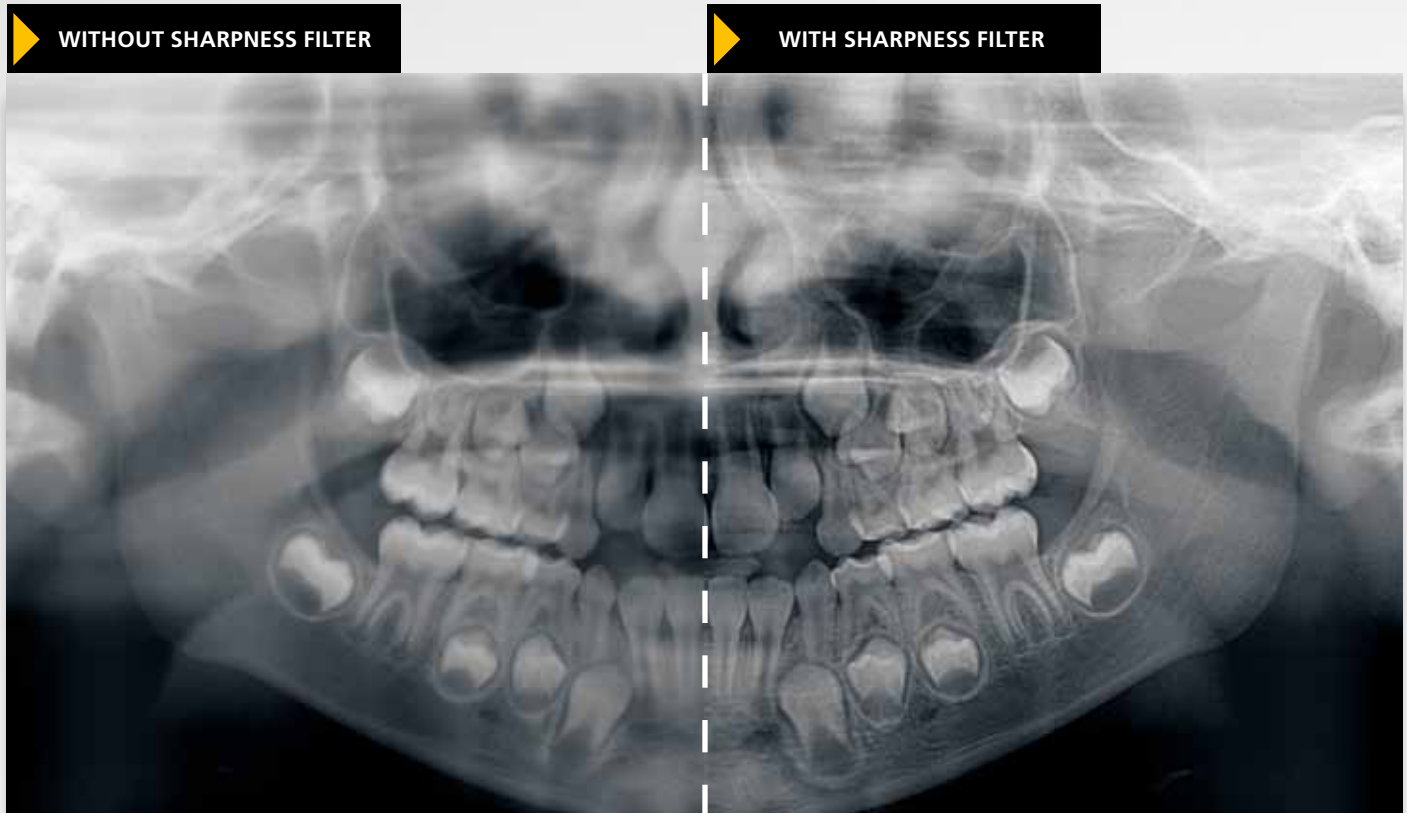

Sharp, high-quality, artifact-free images

The CS 8100 is small, yet powerful. Featuring the very latest software processing algorithms, the CS 8100 minimizes spinal column shadows and produces clear and sharp digital images, ready almost immediately for your review.

When combined with the innovative horizontal design of the high-frequency X-ray DC generator (60 – 90 kV), the CS 8100 ensures that radiation remains constant throughout the exposure for optimal contrast. And an

advanced Active Pixel CMOS sensor, vibration-free motion system and 0.5 mm focal spot ensure smooth capture of highly detailed and contrasted, crystal clear images in seconds.

With just one click, you can even enhance image contrast and sharpness using our powerful artifact-free filter. This filter prevents the creation of dark halos that are often mistaken for caries, lesions or bone loss around radio opaque areas.

Intuitive software and easy sharing

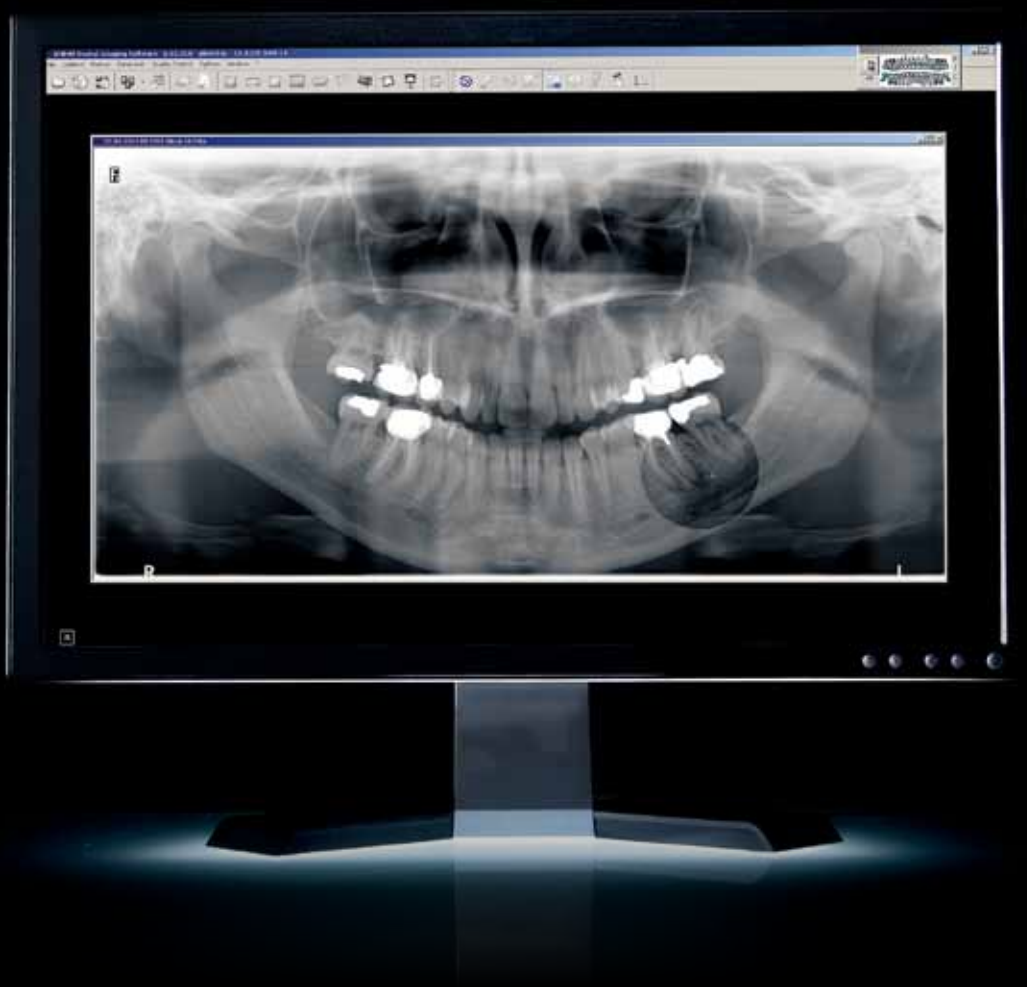

User-friendly tools and enhanced communication

Our intuitive dental imaging software, whether used as a standalone program or integrated with your practice management program, serves as the control panel for all Carestream Dental systems. It helps you analyze images quickly using powerful, user-friendly image processing tools. All features are accessible in just a few clicks to ensure that you get the high image quality you need for an accurate diagnosis.



The CS 8100 and our comprehensive imaging software also greatly improve image sharing and communication. First, all dentists, practitioners or staff members inside the practice can access images on any networked PC. And second, images can easily be sent via email, saved to a USB or printed when sharing images with patients or sending them outside the practice for referrals or insurance inquiries.



[Diagnostic excellence]

See what's not always easily seen

A complete range of programs for every need

In addition to four patient morphologies and three jaw shapes, you can get the desired image you want using a complete range of sophisticated acquisition programs. These versatile programs cover all your everyday panoramic

exam needs, so that you can get the image you require for a proper analysis and recommendation of treatment. The affordable CS 8100 compact panoramic unit is simply everything you need for a successful diagnosis.



Standard panoramic – the most common program



Pediatric panoramic reduces the irradiation level



Lateral TMJ 4 views, mouth open and closed on the same image



Panoramic without TMJ limits the exposure area for follow-up exams



Lateral TMJ 2 views, mouth open or closed



Segmented panoramic limits patient exposure to the area of interest



Sinus program for a clear view of maxillary sinuses



See more with our exclusive 2D+ program

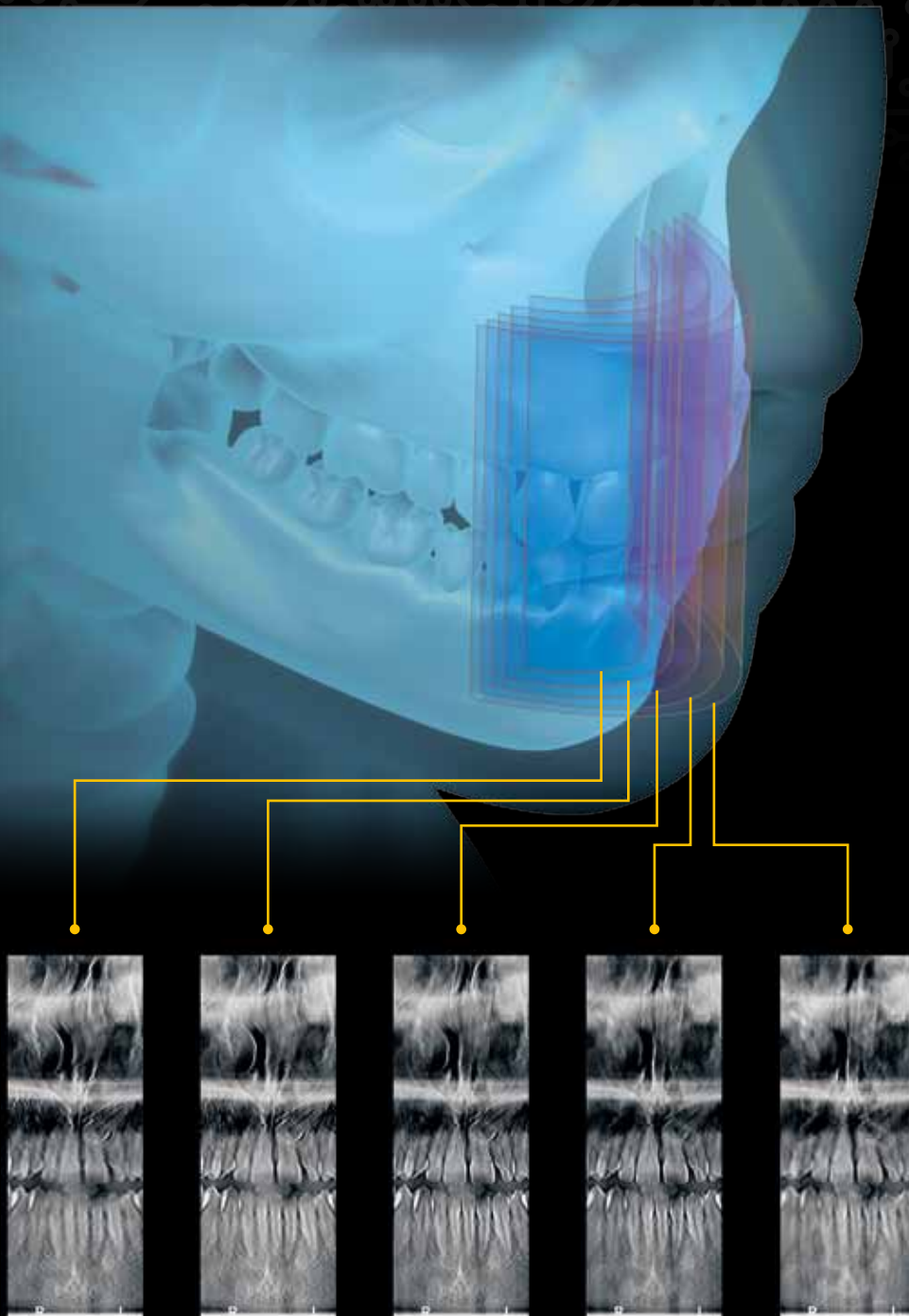

Better diagnoses with thin slices along the jaw

Our exclusive 2D+ program creates results that enable you to see more than what a standard 2D image provides. It focuses on just one area of interest, creating thin slices at regular intervals along the jaw.

This method of assessing the jaw allows for buccal/lingual exploration. In doing so, it helps you to better determine the location of supernumerary teeth, find impactions and apical lesions, or identify the root relationship to the inferior alveolar nerve.

Technical specifications

X-Ray Generator

Tube voltage	60 - 90 kV
Tube current	2 - 15 mA
Frequency	140 kHz
Tube focal spot	0.5 mm (IEC 60336)
Total filtration	> 2.5 mm eq. Al

Panoramic Modality

Sensor technology	CMOS
Sensor matrix	64 x 1312 pixels
Image field	6.4 x 131.2 mm
Gray scale	4096 - 12 bits
Magnification	1.2 (± 10%)
Radiological exam options	Full panoramic, segmented panoramic, maxillary sinus, LA TMJ x 2, LA TMJ x 4, 2D+
Exposure mode	4 patient sizes (Child, Adult: small, medium, large) 3 dental arch morphology
Exposure time	4 to 14 seconds
Input voltage (AC)	220 - 240 V - 50/60 Hz 100 - 130 V - 50/60 Hz*
Unit dimensions	330 (L) x 894 (D) x 1596 (H) mm
Minimum required space	1200 (L) x 1400 (D) x 2400 (H) mm
Weight	72 kg (158.7 lb.)

* Pending registration

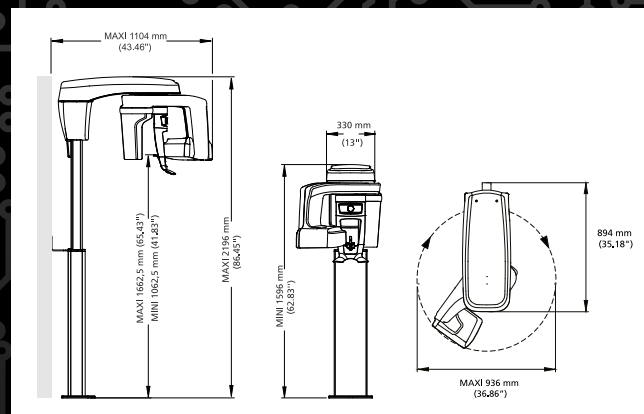

Support you can count on

The simplicity of the CS 8100 ensures that installation and use are as easy and as intuitive as possible. And it is backed by Carestream Dental's expert services and support. Our registered dealers and service providers are certified in quality installation and support, and many services can even be performed remotely, including: configuration, diagnosis, repair, calibration and software updates. This helps keep your service costs and downtime at a minimum – and your practice productivity at the absolute maximum.

Would you like to know more?

Visit www.carestreamdental.com/8100 or contact your local authorized dealer.